

Beauty of Agrivoltaic System regarding double utilization of same piece of land for Generation of Electricity & Food Production

Dhyey D. Mavani, P M Chauhan, Viral Joshi

Abstract— In order to meet global energy demands with clean renewable energy such as with solar photovoltaic (PV) systems, large surface areas are needed because of the relatively diffuse nature of solar energy. Much of this demand can be matched with aggressive building integrated PV and rooftop PV, but the remainder can be met with land-based PV farms. Using large tracts of land for solar farms will increase competition for land resources as food production demand and energy demand are both growing and vie for the limited land resources. Land competition is exacerbated by the increasing population.

These coupled land challenges can be ameliorated using the concept of agrivoltaics or co-developing the same area of land for both solar PV power as well as for conventional agriculture. A coupled simulation model is developed for PV production (PVSyst) and agricultural production (Simulateur mulTidisciplinaire les Cultures Standard (STICS) crop model), to gauge the technical potential of scaling agrivoltaic systems. The results showed that the value of solar generated electricity coupled to shade-tolerant crop production created an over 30% increase in economic value from farms deploying agrivoltaic systems instead of conventional agriculture. Crop yield losses to be minimized and thus maintain crop price stability. In addition, this dual use of agricultural land can have a significant effect on national PV production. If this dual use of land is implemented nationwide, it can make significant impact by generating over 16,000 GWh electricity, which has the potential of meeting the energy demands of more than 15 million people.

Index Terms—Agrivoltaic system, solar photovoltaic (PV) systems, STICS crop model, evapotranspiration, Agroforestry, LER technology, SPV plant, Crop model, PV Subsystems, GECROS

1 Introduction

There is power production of 58303.35 MW from renewable energy sources in the country. The solar energy production is 13114.85 MW in the country. The nation has a target of 100 gigawatt solar energy production by 2022. For this target (100 GW), there will be need of Rs 5 trillion. In most part of the country,

the solar radiations are 5.6 kWh/ m²/day. Manipur has longitude of 93054'19.7'' and latitude of 24048'8''. In Imphal (Manipur) at an altitude of 762 m above mean sea level, temperature ranges 15.9-32.1 0C and annual irradiance varies 2.16-

7.63 kWh/m²/day. The clear sunny days are 129, average rainfall is 1581mm and average clear sunshine hour are 1345.7.

Agri-voltaic is the improved technology in which the installing solar panels and undertaking farming at one time on the same land. This serves two major purposes of electricity generation and crop cultivation. The income from selling of Photo-voltaic generated electricity from one acre land area would be about Rs

7.6 *lakh per year. The power can be used for irrigation pumps and additional power can be given to power grid. In one acre (4047 m²) cultivated land which consists of 63 x 63 m size field, 36 solar panels with silicon polycrystalline cells are arranged in a row along 63 m with zero inclination (horizontal) with a total of 1944 solar panels covering one acre of land. There are 18 rows lying adjacent to the other along 63 m lengthwise. Each rows contains a set of 3 solar panels. The solar panels may be placed 5 m above the ground level. The solar panels may be placed in different configurations with 7.6 m and 11.4 m pitch values and if suitable based on topography solar these can also be arranged like chessboard pattern with air gaps between the set of solar panels. These may reduce solar radiations on crops by 25-30%, 20-25% and 60-80%, respectively corresponding to 7.6, 11.4 m pitch and chess board pattern. Thus the reduction in the noon time may be favourable for crop growth resulting better yield. The farmers will be able to use land for dual purpose, namely to continue the cultivation normally on the ground surface and also use same farming land for power generation. Thus 4.5 acre cultivable will be sufficient for production of 1 MW power which will be additional asset for normal crop production. The partial use of power will serve the irrigation requirement by installing solar water pumping system of 1000 Watt capacity for drawing and pumping 40,000 litres of water per day from hydraulic head of 10 m. This will be sufficient to irrigate 2 acres of land with regular crops. A solar pumping system (1000 W) can ensure Rs 45000 as compared to diesel operated pump over a year. The special NEH region subsidy will be boon for Start Up entrepreneurs for adoption of Agrivoltaic technology of dual purpose in Manipur. The PV module will cost 54% of total system cost and civil work including mounting of structures will be 16% of agrovoltaic system. Thus total system cost excluding land cost will be Rs 6.5 crore for 1 MW requiring 4.5 acre land.*

But for one acre agricultural land, capital investment of Rs 1.0 crore will be required to install agri-voltaic system of 100 kW for dual purpose which provide electricity to the tune of Rs 7.6 lakh and payback period for system will be 13.15 years against the total life of 25 years. In last 11.85 years out of 25 years system

life, accrued benefits will be Rs 90 lakh in addition to the benefit from crops grown in one acre area from one acre land.

Reduction of global radiation under the Agrovoltaico system was more affected by panel density (29.5% and 13.4% respectively for double density and single density), than by panel management (23.2% and 20.0% for sun-track and static panels, respectively).

Radiation reduction, under Agrovoltaico, affected mean soil temperature, evapotranspiration and soil water balance, on average providing more favorable conditions for plant growth than in full light. As a consequence, in rainfed conditions, average grain yield was higher and more stable under agrivoltaic than under full light. The advantage of growing maize in the shade of Agrovoltaico increased proportionally to drought stress, which indicates that agrivoltaic systems could increase crop resilience to climate change.

The benefit of producing renewable energy with Agrovoltaico was assessed using the Land Equivalent Ratio, comparing the electric energy produced by Agrovoltaico cultivated with biogas maize to that produced by a combination of conventional ground mounted PV systems and biogas maize in monoculture. Land Equivalent Ratio was always above 1, it increased with panel density and it was higher with sun tracking than with static panels. The best Agrivoltaico scenario produced twice as much energy, per unit area, as the combination of ground mounted PV systems and biogas maize in monoculture. For this Agrivoltaico can be considered a valuable system to produce renewable energy on farm without negatively affecting land productivity.

The sun has long been a source of free and clean energy in the world of agribusiness, providing crops the nourishment they need to grow. However, the wider energy sector is now starting to utilise solar power for agricultural technology as well. Global investment in solar power generation is growing very fast. Solar energy increased its share of global electricity generating capacity by 50 percent in 2016 alone, overtaking growth in wind, gas and other renewable technologies. The cost of solar photovoltaic cells – the major capital cost in solar installations using that technology – has fallen 80 percent since 20082.

Technological innovation and manufacturing competition have intensified and Chinese manufacturers have gained significantly in market share.

Rooftop solar photovoltaic cell installations – a form of what is referred to in the electricity sector as distributed generation, located at the point of use – are now widespread. They are usually connected to the low-voltage electricity distribution grid and have often benefitted from feed in tariff incentive schemes, whereby the owner receives revenue for feeding surplus electricity into the grid.

Even as incentive schemes have been scaled back or withdrawn, falling capital costs are helping to keep these installations attractive. Solar microgeneration for isolated agricultural applications such as irrigation pumping and electric fencing is also now familiar, flexible and cost effective. Rooftop solar that is not connected to the grid remains an elusive proposition. Even though the cost of solar photovoltaic cells has fallen significantly, the inability of such installations to provide round-the-clock output is a limitation for 24 hour energy intensive processes such as crop drying and food processing. This may change in the longer term as better and more cost-effective battery storage solutions become available, enabling users to make fuller use of their solar modules balancing their own demand. Of increasing significance are largescale solar parks, where arrays of solar PV modules are mounted on frames and owned and operated by developers. These parks now exist at utility scale. Such parks require a great deal of space, so that the rows of modules do not shade each other. They may cover a number of hectares and low-grade agricultural land is ideal for such ventures. The frames are usually low in height and installed over grass. The grass either has to be kept cut – a labor-intensive maintenance expense – or can be combined with suitable activities such as sheep grazing. Recent years have seen renewed experimentation with the concept of “agrivoltaics” (or “agrovoltaics”, to use the spelling adopted in continental Europe), where solar panels and arable farming share the same land. The concept is that narrow panels are mounted at wide spacing on high frames and under-sown with valuable food crops. The panels shade the crops to some extent but the microclimatic effects are complex and site-specific. Shading may be a benefit or a disadvantage, taking into account effects such as the impact of the shade on evaporation rates. The effect on crop yields may therefore be positive, neutral or negative. Agrivoltaics seems generally to be well suited to market gardening, perhaps less so to arable crops. The agrivoltaic system also reduces the maintenance issues associated with more closely spaced solar panels and puts the land to productive agricultural use. However, there are still some issues with cultivation operations to be weighed up, such as limiting the size and efficiency of farm machinery that can be deployed under and between the frames. Of greater potential significance in countries with high levels of insolation is an alternative technology to photovoltaics: concentrated solar plants. Concentrated solar plants use parabolic mirrors to concentrate the sun’s energy on a vessel containing a medium of oil or salt, which becomes superheated. The heat from the oil or salt medium is used to heat water in a heat exchanger and the steam is then used to run conventional steam turbine generating units. These steam turbines can be dispatched to meet electricity demand in a similar way to nonrenewable plants – overcoming a key limitation of photovoltaic technology.

Crucially, the heat in the oil or salt medium is retained for some time after sunset and the plant can therefore continue to generate into the evening electricity peak demand. Concentrated solar plants are not yet widespread but agriculture is well ahead of the game. Last year, a company in South Australia – the driest state on the driest continent on Earth – completed a 1.5MW concentrated solar plant, which it uses for its agricultural operations. It cools 20 hectares of adjacent greenhouses and runs seawater desalination and water treatment plants for the farm's irrigation purposes

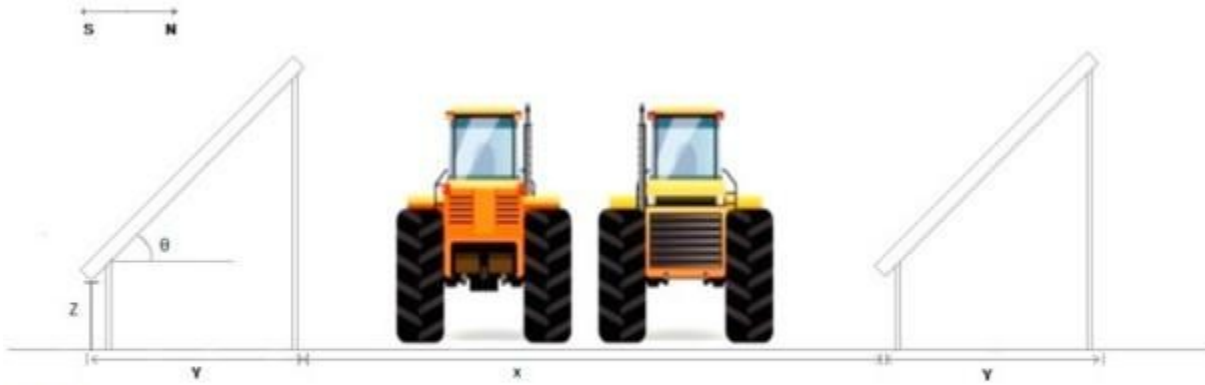
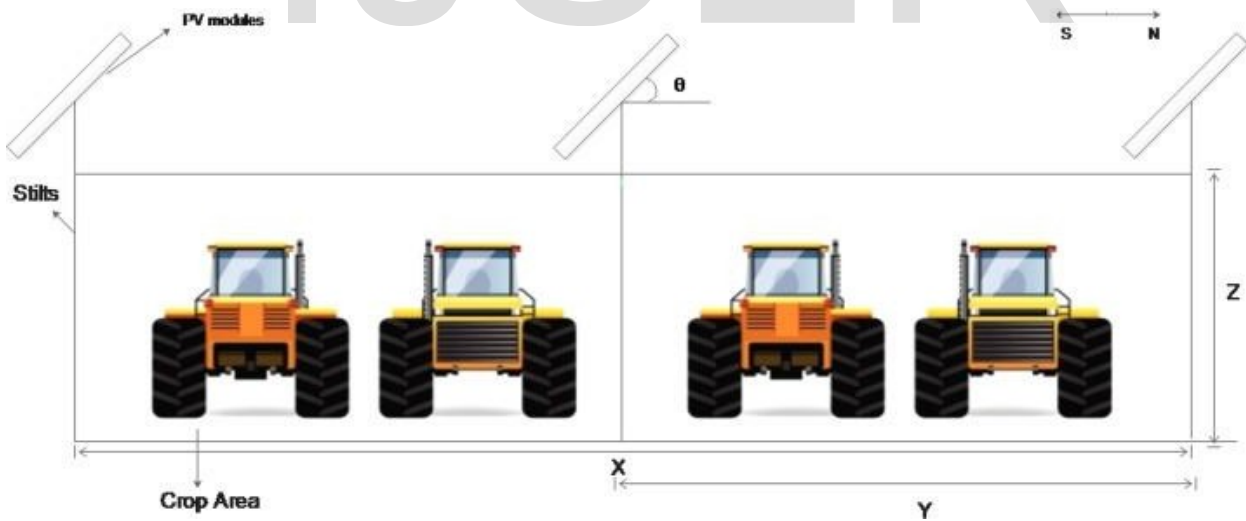

Fig. 1. Agrivoltaic farm schematic having ground mounted PV modules with the area between the panels being used for farming. The spacing between the PV modules has been kept wide enough to allow standard sized farming equipment to pass between the rows.



e 2. Agrivoltaic farm having modules mounted on stilts.

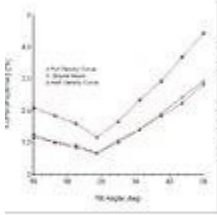

Figure 3. Relation between PV module tilt angle and loss of power output due to shading in selected agrivoltaic system designs.

Figure 4. Sensitivity graph of PV power output with respect to change in spacing.

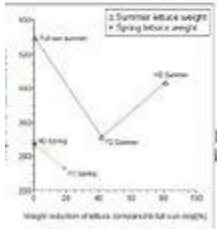
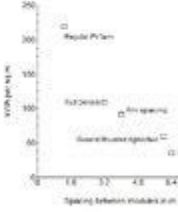
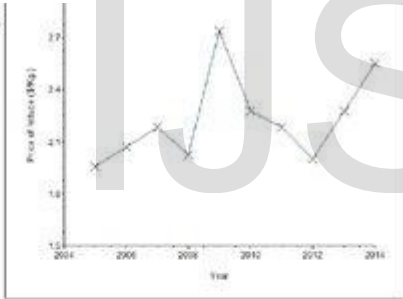
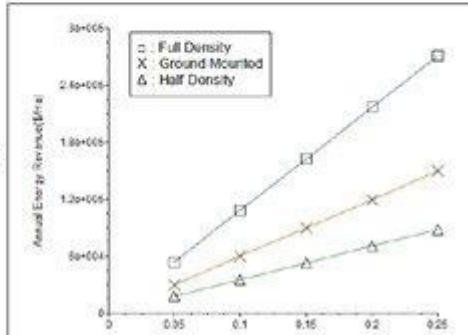

Figure 5. Sensitivity of lettuce plant weight with respect to change in shading values for agrivoltaic farm configurations.

er a 10 year period.



city revenue with
 e in the per unit
 / for various
 configurations.



OBJECTIVES:

Agrivoltaic (AV) systems mix solar photovoltaic panels and crops on the same land unit.

- ▶ A land equivalent ratio of AV systems is a measure of their efficiency

IJSER

- ▶ *Ex ante* modelling predicts a very high productivity of such AV systems.
- ▶ AV may be a win-win option to alleviate the pressure on cropland for energy production.

BACKGROUNDS:

The precursor to the agrivoltaic system was the agroforestry system, which involved intercropping between crops and trees [26]. In the past the solution for the issue of competition for land resources between food and energy production has been addressed by the division of a piece of land for food and energy production [27]. Now following the example of agroforestry, it is possible to combine food and energy production on the same piece of land [28]. This is now known as agrivoltaics and was conceptualized as a solution to the increasing land competition between food and energy production [22]. Although agrivoltaics have been theorized in the early 1980s using the space between PV rows for crops (Figure 1A), the first detailed agrivoltaic farm experiments were only recently performed in Montpellier, France in 2013 [29,30]. This system consisted of stilt mounted PV modules which were 0.8m wide, mounted at a height of 4m and tilted at an angle of 25° [29,30]. A rough schematic of this setup is shown in Figure 1B. Lettuce crops were grown beneath the stilts and the lettuce yields and the behavior of the lettuce crop under shading were analyzed. The results have shown that shading for this crop has no significant effect on the yield due to the adaptive capabilities of lettuce to adjust to the shading caused by the PV arrays. Thus, the same area of land was used to produce both, electricity and food successfully. Dupraz et al. were then able to prove that the yields from the agrivoltaic farm experiment were higher than their respective monosystem equivalent with the use of the LER methodology [31].

LER is used to measure the efficacy of the agrivoltaic system when compared against a monocrop system [31]. Similarly, the LER for the PV output is obtained by comparing the power output of the agrivoltaic system against a standard PV farm. The LER for the solar power output is obtained by taking the ratio of the agrivoltaic system PV output and that of a regular PV farm. One of the primary factors that influence the output of both the PV modules and crop yield is shading, which is not necessarily always negative effect on the latter (as will be discussed below). In addition to shading, the crop output also depends on the photosynthesis process of the crops in converting the incoming solar radiation into biomass [32]. It is difficult to predict the manner in which each plant behaves under shading [33] as shade tolerance of plant depends on the type of foliage and there appears to be correlation between the leaf structure and plant tolerance to environmental conditions [34]. For example, lettuce can adapt itself to shading by increasing its leaf area to maximize its ability to tap the reduced solar radiation levels without significantly affecting yields [30], whereas, shading causes a reduction in wheat yields as it cannot adapt to the reduced light conditions [35].

Experiments conducted on the Paulownia variety wheat grown under shade showed a reduction in wheat yield by 51% [35]. Some of the experimentally verified shade tolerant crops are less common in conventional mass agriculture such as hog peanut, alfalfa [36] yam, taro, cassava and sweet potato [37]. In an agrivoltaic system, the solar power output is maximized by optimizing the tilt angle to tap maximum solar radiation. The tilt angle, θ , is shown in Figure 1. The optimal tilt angle for the PV modules is normally based on the annual

local solar irradiation [38]. Inter-row shading of the PV modules should be minimized, which is generally not a problem in agrivoltaics as the inter-row spacing (x in Figure 1) tends to be larger than a conventional solar farm. The output of the PV module also depends on the operating temperature of a PV module, which is dependent on the ambient temperature, wind speed and solar radiation [39]. The crops in an agrivoltaic setup may improve the temperature of the PV array, but no data is available at the time of this writing to verify that potential. On the other hand, the growth of plants between PV rows can have a negative effect due to dust generation from farming as dust collection on the PV modules decreases the electricity output. The amount of dust collected on the surface of the PV module decreases as the tilt angle increases [40]. Ex-ante simulations performed by Dupraz et al. on an agrivoltaic systems have shown an increased land productivity in the range of 60-70% [31]. The micro-climate conditions in the vicinity of the PV modules and its effect on the crops were studied and it was observed that air temperature and vapor pressure density were unaffected in case of a stilt mounted agrivoltaic system, while PV panels reduce soil temperature and affect the incoming solar flux distribution [30]. The LERs show that the yields from an agrivoltaic system are higher than their respective mono-system yield (solar power and crop yields) [31]. Taking into account the response of the crop yields with respect to changes in climate and its effect on the crop's genetic traits, a model was proposed which showed that the crop relative yield could be factorized into terms that show the effect of the cropping processes on the crop yield [40]. The agricultural wastes from the crops can also be used to produce biofuels, which is used for powering cars, heating systems and also to produce electricity, thus increasing the output of the agrivoltaic system further [41]. An agrivoltaic system can also be formed with a greenhouse by placing PV on the side of the greenhouse roof, which is useful in places such as islands where there are limited land resources [42]. By covering half of the greenhouse roof area with PV modules, it was observed that there was a reduction of 64% in the total available annual solar radiation and the area directly under the shade of the PV modules faced an 82% reduction in annual solar irradiation; and as this shading inhibits growth

in the crops and causes losses on account of lower crop weight and growth inhibition [43]. However, incorporating PV into agriculture can also be beneficial for crops. The shading caused by the PV modules helps in alleviating water evaporation during the summers and proves beneficial especially in the dry season. It was observed that shading resulted in water savings in the range of 14- 29% depending on the level of shade [50]. This benefit could be of significant use in areas experiencing severe droughts, exacerbated by climate change. PV modules have also been shown to alleviate soil erosion by reducing the moisture evaporation [44]. In addition, an agrivoltaic farm can act as a standalone power source for powering irrigation and pumping schemes in locations having electricity shortage or non-existent grid supply, thus ensuring food security [45]. Finally, an agrivoltaic solution can also be offered as a solution to the resentment against conversion of arable farmlands into PV farms due to policies which favor PV farms causing a reduction in food production [46]

DISCUSSION:

Solar Power Plants are land intensive and require approximately 2 hectares per MW. The diffuse nature of solar energy incident on earth requires that the solar photovoltaic systems that convert it directly to electricity have to be installed and operated on large surface areas in

order to meet the energy demand and to be cost effective. Apart from land requirements, solar power plants also face challenge of high costs at two fronts: (i) due to low plant utilization factor, per unit cost of generation is relatively high, (ii) due to this same factor, the cost of transmission per unit of power from solar is also comparatively high. In other words, the requirement for capital investment in power transmission system for solar power project in terms of per unit of electricity generated is about four times that of conventional coal/ gas based power plants. So, this energy demand can be met by either installing rooftop PV systems or by installing land-based PV farms. Land-based PV farms require large tracts of land but can lead to competition for land resources as a tract of land occupied for solar PV generation cannot then be utilized for food production, whose demand is also increasing as world population increases.

The challenge of food and energy production can be tackled jointly by employing the concept of Agro-voltaic systems (AVS) which has been gaining popularity in recent years. Agro-voltaic system involves cultivation of crops under the shade of solar panels on the same land. This gives an added advantage of food and energy production being done and managed on the same piece of land. Crops grown between or under the panels are generally shade-tolerant and whatever decrease occurs in crop production can be compensated by the generation of electricity from the solar panels which can prove to be an added source of income for the farmer. These types of systems have seen rapid expansion in recent years. Distributed solar power generation would be facilitated if agriculture lands could be used for generation of solar power without adversely affecting agriculture production.

Benefits of Agrivoltaic:

Agrivoltaic allows double utilization of the same piece of land for generation of electricity and food production; the System will also have the following features and benefits that will significantly contribute to the economic and general progress of the rural people particularly farmers.

Sr.No.	Features	Benefits
1	Growing crops during dry season	The Agrivoltaic system will allow for the growth of shade loving thereby increasing the productivity of the land during the dry months while making it more fertile. These crops will allow agricultural activity throughout the year and increase the number of crop cycles to two or more and also open up new markets and revenues for farmers.
2	Water efficiency	Water used for cleaning the solar plant can be recycled for irrigation of crops. Drip irrigation and rain water harvesting along with reverse osmosis water treatment will ensure optimum usage of water. Water will also be pumped using solar energy.
3	Source of employment to local population	Agrivoltaic system generates better employment opportunities for the local population in three areas (i) solar plant maintenance and agricultural activity. This will generate year round incomes for the local population thereby raising the standard of living in the region. (ii) Constant availability of electricity will help rural population to develop small business and manufacturing units that will employ rural people on a regular basis.

		(iii) Crop processing and preservation units can be developed will help to fetch better return of farm production and decrease migration of rural youth in city.
--	--	--

Agrivoltaic Methods:

There are two methods of Agrivoltaic. The solar PV modules can be either mounted on the ground (or near the ground) with the space between rows of modules used for agriculture and being large enough to accommodate farming equipment as shown in Fig.1 or be mounted on elevated structure with the area underneath the stilts used for agriculture as shown in Fig.2.

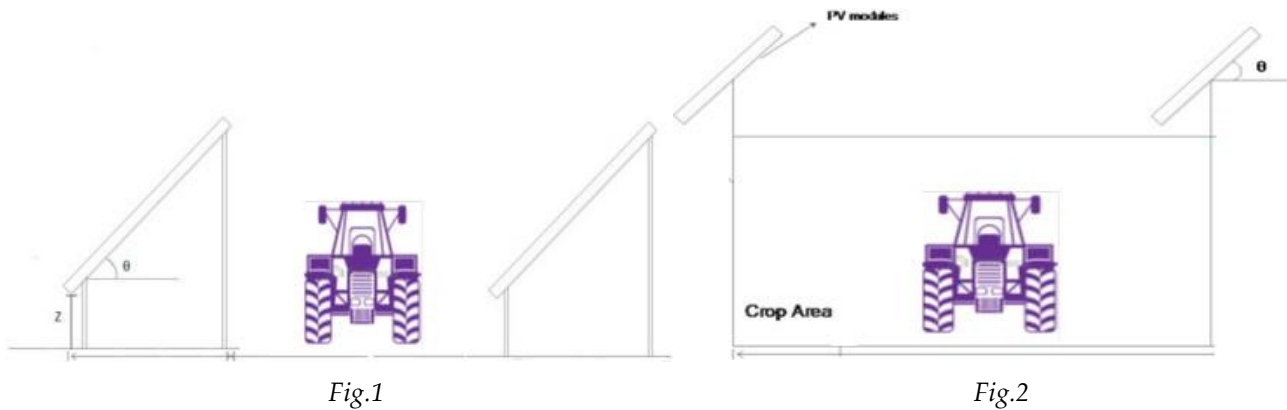

1. Agriculture between two raw of the conventional SPV plant : Case Study on Crop Cultivation between the panels of a 3 MW solar power plant
2. Agriculture under SPV power plant (Elevated Structure)
 - (a) Semi-Transparent solar module roof type structure
 - (b) Cylindrical solar cell roof type structure:
 - (c) Conventional solar panel type roof structure

METHODS & MATERIALS:

Using the existing literature summarized in Section 2 a generalizable solar PV model for agrivoltaic systems is created and then coupled with a crop model and solar radiation model to quantify the performance of agrivoltaic systems. The performance of the PV is a function of the incoming solar irradiation for the PV modules. Likewise, the crop yields depends upon the radiation conversion efficiency which gives the efficiency of the process of converting the photosynthetically active radiation (PAR), which is between 400-700nm (3.1-1.77 eV), into dry matter.

3.1 Solar PV system model The solar PV modules can be either mounted on the ground(or near the ground) with the space between rows of modules used for agriculture and being large enough to accommodate farming equipment as shown in Figure 1 or be mounted on stilts with the area underneath the stilts used for agriculture as shown in Figure 2. In Figure 1 and 2, X is the distance [m] between PV module rows used for agriculture, Y is the horizontal projection of the PV [m], θ is the tilt angle in degrees and z is the height [m] of the stilts. As can be seen in Figure 2, all the land below the stilts is used for agriculture. The height of the stilts and spacing from adjacent stilts is such that standard farming equipment can pass

below the stilts to harvest the crop without affecting the PV modules. This configuration ensures better land use as compared to the ground mounted PV modules as the land underneath the modules in the latter cannot be utilized. Although, obviously the increased land use efficiency comes with a higher cost in racking. The crop selection, mounting height, optimal tilt angle, solar irradiation and local climate play a role in the optimal selection of PV system geometry for an agrivoltaic system. The configuration for the PV is determined by formulating an optimization problem with the objective of maximizing the solar irradiation incident on the PV which in turn is proportional to the power output of the PV module while taking into account the additional land cost from minimizing inter-row shading. The effect of this variance is included in the objective function on the optimization problem [38]. To compensate for shading and its effect on crop yields, the PV density can be reduced [31] or by the use of semitransparent panels having a radiation transmission rate of 50% or more [47]. The sensitivity for the PV system output per unit area was modeled in PVSyst (version 6.34) with respect to the tilt angle, conversion efficiency and the row spacing of modules. A case study is evaluated for agrivoltaic grid-connected farm located in Kansas City (Lat:39.0997o Long:94.5783o Alt: 311m).

3.2 Crop Model The Simulateur multiDisciplinaire les Cultures Standard. (STICS) crop model is used to obtain crop yield data for various types of crops as the model uses generic parameters, which are applicable to most crops [48]. STICS is a time step model which provides crop yields for various environmental conditions [48]. The STICS model consists of four main modules that pertain to the growth of the plant, interaction of the soil with the plants, the crop management module dealing with the farming techniques applied to the crops and the micro climate model which enumerates the effects of climate and soil water content on the climate surrounding the immediate vicinity of the crops. The type of crop being grown on the agrivoltaic farm can be classified as shade tolerant or shade intolerant depending on their ability to withstand low light levels

3.3 The Combined Model and Case Study A sensitivity analysis is performed to explore the behavior of lettuce, a shade tolerant crop, when planted between rows of ground mounted PV modules and when planted underneath stilt mounted PV modules to ascertain the yields in both configurations due to the variation in the levels of shading. The sensitivity of the lettuce yield per hectare with respect to changes in the level of shading and the harvest during the time of the year will be examined. The optimal mounting configuration for the PV modules is obtained from the simulation based on the local solar irradiation data. Trinia Solar TSM300-P14A PV modules were used for simulation. The shading on the PV module varies according to the time of the year and height of the crops planted between the module rows. The PV power output by the different PV module configurations of stilt mounted (Figure 2) and ground mounted (Figure 1) were simulated. The ground mounted configuration of the agrivoltaic farm consisted of PV arrays mounted 1m above ground with a spacing of 6m. The spacing between the PV modules has been chosen such that industrial size harvesters and standard farming equipment can pass through between the PV module rows while maintaining a safe distance from the PV arrays. For the ground mounted configuration, the PV arrays have a dimension of 20m x 1m and the dimension for the farm between the modules are 20m x 5m. The stilt mounted agrivoltaic farm simulated had two sub- configurations; half density (HD) and full density (FD). In both the configurations, the PV modules are mounted at a height of 4m above the ground. In the HD configuration, there are two PV module arrays of 20m x 1m spaced 6.4m apart while in the FD configuration, there

are four PV module arrays spaced 3.2m apart. Both the stilt mounted configurations impart shading on the crop below. Lettuce is good crop for such an agrivoltaic system as it can withstand shading up to 30% [30]. Lettuce has a growth period of 6-8 weeks and grows up to a height of 6-12 inches and is generally grown in the late spring or early fall periods as the crop thrives in cool climates. The weights used for the simulation was experimentally determined for individual lettuce plant was 561gms for a summer harvest and 312g for a spring crop in clear sunshine [30]. For lettuce, STICS provides the yield per hectare of the aerial biomass, which is the combined weight of the crop heads per hectare.

RESULTS:

Performance of the PV Sub-system

The Kansans City PV system was simulated and the results showed that a fixed optimal tilt angle of 25° maximized PV output. At this tilt angle, the shading loss for the ground mounted configuration was 0.6% and for the FD stilt mounted configuration was 1.3%. The annual kWh output total and as a function of month of the PV modules for different configurations is shown in Tables 1, 2 and 3 for the ground mounted, full density and half density configurations respectively. A sensitivity analysis was performed on the tilt angle and row spacing. The variation of the tilt angle is shown in Figure 3 for the ground mounted, stilt mounted FD and HD farms. P_{tilt} is the power output at a given tilt angle and P_{optimal} is the optimal tilt angle. As can be seen in Figure 3, the power output is affected more by the tilt angle in the FD configuration due to a lower spacing distance between the PV panel rows. To gauge the sensitivity of the PV output with respect to changes in row spacing, a second ground mounted agrivoltaic farm was simulated having a spacing of 4m between the panels and the power outputs of this new farm were compared against the ground mounted, FD and HD agrivoltaic farm. In addition, a conventional industrial/utility scale solar PV farm is simulated to compare the power outputs with that of the agrivoltaic farm to determine the effectiveness of the agrivoltaic setup. The scale solar PV farm has the same dimensions as that of the agrivoltaic PV array, but has a spacing of 3m between the rows of modules. The mounting of the PV arrays is the same as that of the agrivoltaic setup and the shading effect caused by the modules have also been taken into account. The regular PV farm has PV arrays having dimensions of 20m x 1m tilted at 25° with a spacing of 1.25m. Such systems suffer from greater shading losses than an agrivoltaic setup, but more than make up for the loss with increased power density. The overall efficiency of the system is 11.96% compared to the roughly 1% higher efficiencies from the agrivoltaic systems with less row to row shading. However, as can be seen in Figure 4, conventional solar PV farms produce roughly double the electricity output per unit area of ground than even the full density agrivoltaic setup. The annual energy per unit area output of the new farm is shown in Figure 4. The sensitivity in this case is the change in the kWh/m² of different agrivoltaic farm configurations with respect to the spacing between PV module rows. The HD configuration is aimed at improving the available sunlight for the crops plant underneath the PV modules [30] and clearly has a reduced PV output compared to optimized farms and even modest spacing.

CropModel:

The growth of lettuce between the PV modules was simulated with STICS, which provided the number of lettuce plants per m² and weight of an individual plant for a lettuce crop grown under standard temperature and soil conditions. The crop yields (Y) in tons per hectare are calculated by: $Y [\text{Tons}/\text{Ha}] = (W \times d)/100$ (1) where W is the fresh weight of lettuce plant (g) and d is the plant density per square meter. In Simulation of the ground mounted agrivoltaic farm on STICS resulted in a plant density of 9 per m² and the individual weight of each lettuce plant is 557 g. With this setup it was observed that for lettuce grown in the summer there was a 42% reduction in yields in FD and 19% at HD with respect to the weight of lettuce grown under clear sky conditions. It was also observed that for lettuce grown in the spring there was no significant effect on the lettuce yields in HD and a 21% reduction in yields for FD which is significantly more for a summer grown crop. This was due to the moderate shading conditions

during the spring planting. The moderate shading conditions during spring combined with the adaptive ability of lettuce and the HD configuration resulted in yields remaining significantly unaffected. The crop yields for the various agrivoltaic farms simulated are summarized in Table 4. The crop model sensitivity depends on the shading as it affects the amount of incident solar irradiation intercepted by the crops which in turn affects the yield, which depends on the number of grains/heads per sq.m and the weight of each individual grain/head. As a result, the sensitivity for the crop model can be now described as the change in number and weight of grains/heads with respect to the shading as shown in Figure 5

INNOVATION:

A system combining soil grown crops with photovoltaic panels (PV) installed several meters above the ground is referred to as agrivoltaic systems. In this work a patented agrivoltaic solar tracking system named Agrovoltaico®, was examined in combination with a maize crop in a simulation study. To this purpose a software platform was developed coupling a radiation and shading model to the generic crop growth simulator GECROS. Control simulations for an irrigated maize crop under full light were added to results.

Reduction of global radiation under the Agrovoltaico system was more affected by panel density (29.5% and 13.4% respectively for double density and single density), than by panel management (23.2% and 20.0% for sun-track and static panels, respectively).

Radiation reduction, under Agrovoltaico, affected mean soil temperature, evapotranspiration and soil water balance, on average providing more favorable conditions for plant growth than in full light. As a consequence, in rainfed conditions, average grain yield was higher and more stable under agrivoltaic than under full light. The advantage of growing maize in the shade of Agrovoltaico increased proportionally to drought stress, which indicates that agrivoltaic systems could increase crop resilience to climate change.

The benefit of producing renewable energy with Agrovoltaico was assessed using the Land Equivalent Ratio, comparing the electric energy produced by Agrovoltaico cultivated with biogas maize to that produced by a combination of conventional ground mounted PV systems and biogas maize in monoculture. Land Equivalent Ratio was always above 1, it increased with panel density and it was higher with sun tracking than with static panels. The best Agrivoltaico scenario produced twice as much energy, per unit area, as the combination of ground mounted PV systems and biogas maize in monoculture. For this Agrivoltaico can be considered a valuable system to produce renewable energy on farm without negatively affecting land productivity.

Agri-voltaic is the improved technology in which the installing solar panels and undertaking farming at one time on the same land. This serves two major purposes of electricity generation and crop cultivation. The income from selling of Photo-voltaic generated electricity from one acre land area would be about Rs 7.6 lakh per year. The power can be used for irrigation pumps and additional power can be given to power grid. In one acre (4047 m²) cultivated land which consists of 63 x 63 m size field, 36 solar panels with silicon polycrystalline cells are arranged in a row along 63 m with zero inclination (horizontal) with a total of 1944 solar panels covering one acre of land. There are 18 rows lying adjacent to the other along 63 m lengthwise. Each rows contains a set of 3 solar panels. The solar panels may be placed 5 m above the ground level. The solar panels may be placed in different configurations with 7.6 m and 11.4 m pitch values and if suitable based on topography solar these can also be arranged like chess board pattern with air gaps between the set of solar panels. These may reduce solar radiations on crops by 25-30%, 20-25% and 60-80%, respectively corresponding to 7.6, 11.4 m pitch and chess board pattern. Thus the reduction in the noon time may be favourable for crop growth resulting better yield. The farmers will be able to use land for dual purpose, namely to continue the cultivation normally on the ground surface and also use same farming land for power generation. Thus 4.5 acre cultivable will be sufficient for production of 1 MW power which will be additional asset for normal crop production. The partial use of power will serve the irrigation requirement by installing solar water pumping system of 1000 Watt capacity for drawing and pumping 40,000 litres of water per day from hydraulic head of 10 m. This will be sufficient to irrigate 2 acres of land with regular crops. A solar pumping system (1000 W) can ensure Rs 45000 as compared to diesel operated pump over a year. The special NEH region subsidy will be boon for Start Up entrepreneurs for adoption of Agrivoltaic technology of dual purpose in Manipur. The PV module will cost 54% of total system cost and civil work including mounting of structures will be 16% of agrovoltaic system. Thus total system cost excluding land cost will be Rs 6.5 crore for 1 MW requiring 4.5 acre land.

But for one acre agricultural land, capital investment of Rs 1.0 crore will be required to install agri-voltaic system of 100 kW for dual purpose which provide electricity to the tune of Rs 7.6 lakh and payback period for system will be 13.15 years against the total life of 25 years. In last 11.85 years out of 25 years system life, accrued benefits will be Rs 90 lakh in addition to the benefit from crops grown in one acre area from one acre land.

FIGURES:

Figure Captions

Figure 1. Agrivoltaic farm schematic having ground mounted PV modules with the area between the panels being used for farming. The spacing between the PV modules has been kept wide enough to allow standard sized farming equipment to pass between the rows.



Figure 2. Agrivoltaic farm having PV modules mounted on stilts.

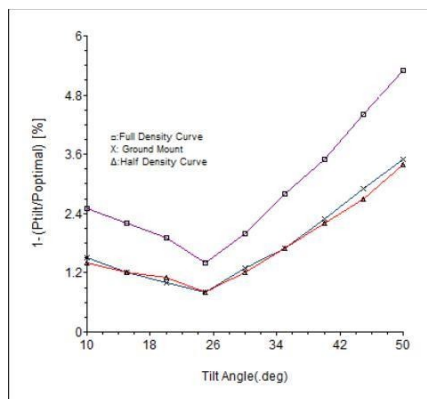
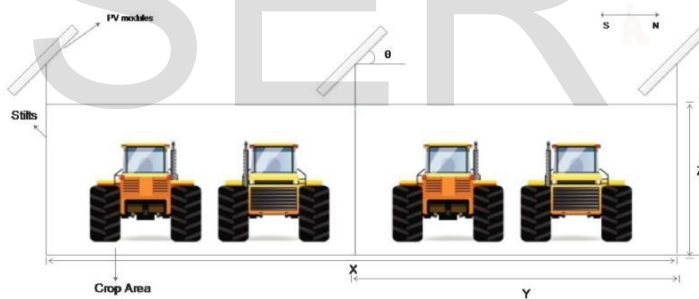

Figure 3. Relation between PV module tilt angle and loss of power output due to shading in selected agrivoltaic system designs.

Figure 4. Sensitivity graph of PV power output with respect to change in spacing.

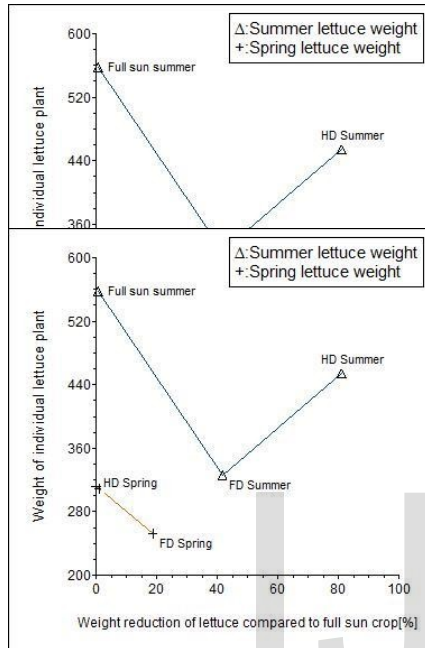

Figure 5. Sensitivity of lettuce plant weight with respect to change in shading values for agrivoltaic farm configurations.

Figure 6. Sensitivity analysis of lettuce prices over a 10 year period.

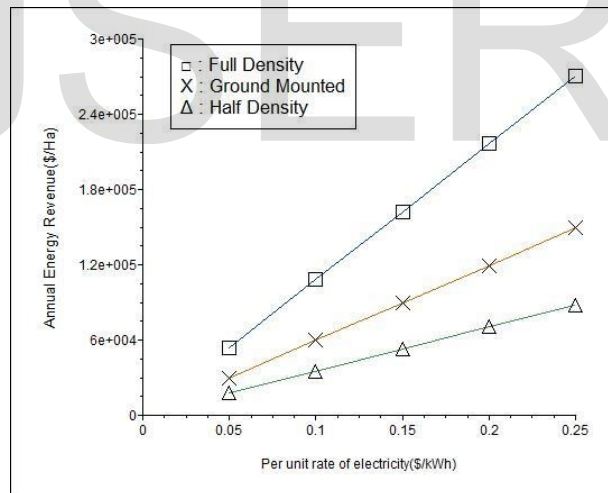
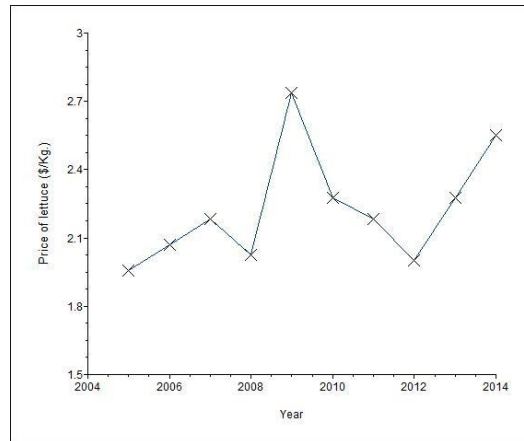
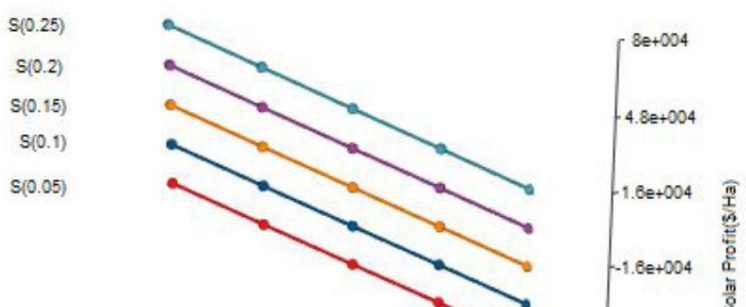
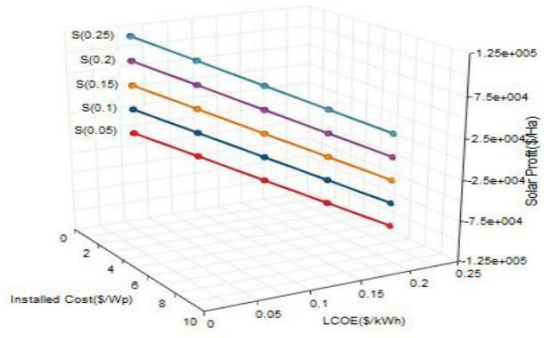
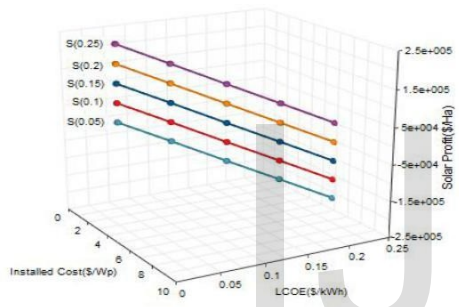

Figure 7. Electricity revenue with respect to change in the per unit cost of electricity for various agrivoltaic farm configurations.

IJSER

Figure 8. Effect of electricity cost and installed costs on the solar profit for full density (8A), ground mount (8B) and half density (8C), configurations respectively.



IJSER

Future Work:

The most pressing area of future work is to develop real-world proof of concepts. This could first be done in a controlled fashion by turning a fraction of a grape vineyard into an agrivoltaic farm and comparing the grape yield from the converted farm to the uncovered farm used as a control. This study had no plant-biology/physiology considerations for the partial shade effects caused by agrivoltaics and such a future proof of concept could begin to quantify the impacts of partial shading from the PV on grape plant health and productivity. Careful records can be kept on any secondary effects both negative (e.g. possible increases in labor costs due to increased harvesting time due to more restricted access to vines for harvesting) or positive effects (e.g. improved microenvironments increasing grape yields due to decreased soil temperatures and thus reduced evaporation from PV-related ground shading). Similarly, such a pilot test bed would also have a co-deployed PV system completely unshaded by grapes to compare solar electric yields to with the agrivoltaic system. Both PV systems could be compared to SAM simulations. These data could then be used to provide a more accurate economic model to create a sound business case for such systems. If these field studies also prove promising, there are other opportunities to improve the mechanical design of an agrivoltaic system located on a grape farm. The existing structures made for the grape plantations could be used to mount solar panels and thus a major installation cost can be saved. Depending on the mechanical stability of the existing trellises this may only be possible for new installations where the trellises are designed to meet mechanical specifications of both grape and PV production. In this case the trellises can be used as the base structure and solar modules can be fabricated to be mounted on them. This will ensure saving time and energy to dig additional holes in the ground as well as the material cost to hold the solar modules will decrease with an added advantage of free space under the module to facilitate farming. This study assumed human labor for harvesting. However, there are automated harvesting machines for grapes, which are economic on large scale farms [70]. Future work should also consider the design of an agrivoltaic grape farm, which has sufficient spacing to enable automated grape harvesting [71]. This will entail additional spacing between trellises and the impact on grape production per unit area will need to be taken into account and weighed against the additional revenue from the PV electrical production.

There are also several potential integrated benefits such as the use of the sprinklers for irrigating the farms can help in cleaning the dust particles from the solar modules. This loss can be non-trivial in certain areas (e.g. 15-25% decline in annual electricity production from solar PV) [39]. A future study is needed to quantify this benefit for increased solar electric yield in specific regions and then compared to the cost of manual or automated cleaning for dedicated PV cleaning systems. If the proof of concept study shows an unacceptable decline in grape production cultivators may still be able to use agrivoltaics on grape farms and have added revenue generation by using a tertiary source for intercropping. For example, a 3 part system could be made up of

solar PV, grapes and a shade loving crop like the betel leaf, which is also known as the 'neglected green gold of India' [72]. Betel leaves are in great demand in several countries of the world apart from India and generate additional revenue after drying [73]. Similarly, the shade occurring due to solar modules can also be used to cultivate medicinal plants like ginger, tulsi (*Ocimum tenuiflorum*), which need shade to proliferate. Farmers have explored intercropping of grape farms with other crops on an experimental basis [74] and this could potentially make the business model of agrivoltaics even more promising as solar PV + grape vineyards can attract tourists and open more opportunities of income.

DISCUSSION & FUTURE WORKS:

The agrivoltaic system investigated in this study is designed to accommodate modern farming equipment which spread dust causing soiling of the PV modules and affecting the power output as dust diminishes the transmittance of the transparent collectors on the PV module surface [49]. This would require cleaning of the PV modules at periodic intervals in relation to the agricultural activity to maintain optimum electricity output. This could be done either as part of the maintenance schedule of the standard farming routine or be accomplished through the use of irrigation spraying. The PV arrays can act as a rainwater and irrigation runoff channel, which can drain the rainwater directly on the crops, depending upon the system geometry. When used in conjunction with a sprinkle irrigation system, the water sprinkled on the PV arrays would clean the PV arrays and drain off on the crops, thus facilitating effect monsoon climate where annual rainfall is concentrated mainly between June to September followed by a dry period throughout the year. In excessively dusty atmospheres, PV modules with self-cleaning glass surface [66] can be used as a solution to keep the PV modules clean at all times without the need of frequent cleaning. Further work in this area is needed to determine both the technical and economic viability of such an approach. More advanced PV systems could be designed to further reduce the impact on agricultural yields of agrivoltaic systems. For example, the tilt angle of the PV modules can be varied using an automated systems such that the shading is at a minimum during the germination stage to prevent growth inhibition of the crops and the PV modules can then be tilted back to its optimal tilt angle. This would increase both the crop yield and the electric yield. In general seasonal tilt adjustments are not made on large scale PV systems that are not dual axis trackers for economic reasons, but the economics may shift in an appropriately spaced agrivoltaic system. Partial shading offered by the PV arrays can help protect temperature sensitive crops from excessive heat. To strike the right balance between the PV power output and crop growth, simulations such as those performed in this study are needed to determine the optimal density of PV modules is based on the tilt angle, row spacing, agrivoltaic farm area and morphological traits of the crops with respect to shade tolerance. Significant future work is needed to find the optimal for yield for both lettuce investigated here, but also other shade resistant crops. Many crops have not been evaluated for agrivoltaic applications. Future work is needed in the field of agrivoltaic systems to extend its implementation to shade tolerant greens

other than lettuce including: arugula, Asian greens, chard, collard greens, kale, mustard greens, parsley, sorrel, spinach, and scallions [67-68]. In addition, other brassicas such as broccoli, kohlrabi, and cabbage will also grow in partial shade [67-68] and other crops such as hog peanut, alfalfa [36] yam, taro, cassava and sweet potato [37] should be investigated for agrivoltaic applications after studying the morphological traits of such crops to understand their behavior and light requirement patterns during different stages of their life from germination to harvest. The shade tolerance depends on the radiation interception efficiency (RIE) of the leaves and is independent of the level of shading.

Hence, when lettuce is grown under shading, it compensates for the constant RIE by increasing its leaf area to maximize its ability to tap the most of the incoming solar radiation [30]. There is currently a large dearth of information on the shade tolerance of crops and those with data are not overly promising. For example, maize grown under shade experiences a reduction in stem height, leaf area, and photosynthesis rate [69]. This may be a useful application of citizen science [70]. The bench-mark economic values in this study only cover the revenue per hectare per year for agrivoltaic farms.

The highest value of earnings per year comes from a conventional optimized solar farm (values from Figure 4) and the per unit cost of electricity yields, \$274,000/Ha/year.

Converting agricultural farms into solar farms, however, has notable drawbacks as discussed in the introduction such as increased food prices and the concomitant hunger related diseases. Therefore, the approach investigated here provides for an increase in farm revenue per unit area while only reducing agricultural output on the farm modestly (12%, 34% and 36% reduction for half, full density, and ground mounted, respectively). To arrive at an economic optimum a full life cycle analysis would need to be done on the agrivoltaic systems comparing the value output to the levelized cost of the systems over their life cycle. This analysis would include sensitivities on variables such as the escalation rates in food, energy prices and farm input costs as well as financing as they can all be variable. Even without a full life cycle analysis the results from this study indicate that agrivoltaic farms use water usage. This scheme would prove effective in a country like India that has a distinct could be profitable for conventional farmers and as population and energy use continue to rise more efficient use of land will become necessary. It is instructive to calculate the power potential of the current agricultural land if converted to an agrivoltaic farm. As of 2012, the total area under lettuce cultivation in the USA was 267,100 acres (108,000 Ha) [71]. Considering only the lettuce cultivation area of the U.S. the solar power potential is substantial as shown in Table 6. Both the Half Density and Ground Mounted arrays could support over 40GW of PV using the area currently used for lettuce production, while the full density arrays could support over 77 GW of additional PV capacity. To put this number in perspective the Solar Energy Industries Association expects the entire U.S. PV installed capacity to only reach 40GW in 2017 [72].

Combining solar photovoltaic panels and food crops for optimising land use: Towards new agrivoltaic schemes

The need for new sources of renewable energies and the rising price of fossil fuels have induced the hope that agricultural crops may be a source of renewable energy for the future. We question in this paper the best strategies to convert solar radiation into both energy and food. The intrinsic efficiency of the photosynthetic process is quite low (around 3%) while commercially available monocrystalline solar photovoltaic (PV) panels have an average yield of 15%. Therefore huge arrays of solar panels are now envisaged. Solar plants using PV panels will therefore compete with agriculture for land. In this paper, we suggest that a combination of solar panels and food crops on the same land unit may maximise the land use. We suggest to call this an agrivoltaic system. We used Land Equivalent Ratios to compare conventional options (separation of agriculture and energy harvesting) and two agrivoltaic systems with different densities of PV panels. We modelled the light transmission at the crop level by an array of solar panels and used a crop model to predict the productivity of the partially shaded crops.

These preliminary results indicate that agrivoltaic systems may be very efficient: a 35–73% increase of global land productivity was predicted for the two densities of PV panels. Facilitation mechanisms similar to those evidenced in agroforestry systems may explain the advantage of such mixed systems. New solar plants may therefore combine electricity production with food production, especially in countries where cropping land is scarce. There is a need to validate the hypotheses included in our models and provide a proof of the concept by monitoring prototypes of agrivoltaic systems.

REFERENCES:

Review of Literature:

Marrou et. al. (2013) studied the impact of solar panel shade on crop water use underneath them. The bulk actual evapo-transpiration (AET) of lettuce and cucumbers grown under AVS and control was calculated by water-balance equation. To analyze the modifications in AET due to shade of solar panels, various drivers were identified. It was found that crop AET determined by the water balance method got reduced by about 10-30 % in the AVS when the available light under the panels was 50-70 % of full radiation. The experiment showed that water-use efficiency in plants grown under AVS can be increased by selecting crop varieties which cover the soil quickly, thereby reducing evaporation from the soil and leaving more amount of water for plant ET, thereby increasing biomass production.

Raul Urena-Sanchez et. al. (2012) have reported the cultivation of tomato in a greenhouse on whose rood flexible solar panels had been fitted. The aim was to study the effect of panels on yield and fruit quality of tomatoes. The solar panels were mounted

on two parts of the roof in different arrangements, though both blocking out 9.8% of its surface area. There was no difference observed in total or marketable production in all three arrangements (the third being control). The mean mass and maximum diameters of fruits obtained from control were more than that in the two panel arrangements. Fruits in control also matured earlier and with intense red colour than in the two panel arrangements. Though, this had no effect on the market price of all the fruits obtained in all treatments

REFERENCES:

- [1] Droege P, *Renewable Energy and the City: Urban Life in an Age of Fossil Fuel Depletion and Climate Change*, *Bulletin of Science, Technology & Society* 2002;22(2),87–99.
- [2] Moss RH, Edmonds JA, Hibbard KA, Manning MR, Rose SK, van Vuuren DP. *The next generation of scenarios for climate change research and assessment* . *Nature*, 2010;463(7282), 747–756.
- [3] *Stern Review- The Economics of Climate Change*. Available at (accessed on October 18, 2014)
- [4] Flavin C, *Slowing Global Warming*, *Environmental Science & Technology*. 1990;24(2), 170- 171.
- [5] Steinberg M, *Fossil Fuel Decarbonization Technology for Mitigating Global Warming*, *International Journal of Hydrogen Energy* 24, no. 8; 1999, pp.771–77
- [6] El-Fadel M, Chedid R, Zeinati M, Hmaidan W. *Mitigating energy-related GHG emissions through renewable energy* . *Renewable Energy*, 2003;28(8), 1257–1276.
- [7]. Sims REH. *Renewable energy: a response to climate change*. *Solar Energy*, 2004;76(1-3), 9–17.
- [8] Longo A, Markandya A, Petrucci M. *The internalization of externalities in the production of electricity: Willingness to pay for the attributes of a policy for renewable energy*. *Ecological Economics*, 2008;67(1), 140–152.
- [9] Tsoutsos T, Papadopoulou E, Katsiri A, Papadopoulos AM. *Supporting schemes for renewable energy sources and their impact on reducing the emissions of greenhouse gases in Greece*. *Renewable and Sustainable Energy Reviews*, 2008;12(7), 1767–1788.
- [10]. Granovskii M, Dincer I, Rosen M. *Greenhouse gas emissions reduction by use of wind and solar energies for hydrogen and electricity production: Economic factors*. *International Journal of Hydrogen Energy*, 2007;32(8), 927–931.
- [11] Pearce JM, *Photovoltaics - A Path to Sustainable Futures* , *Futures*, 2002;34(7), 663-674.
- [12] Barker PP, Bing JM. *Advances in Solar Photovoltaic Technology: An Applications Perspective* , *IEEE Power Engineering Society General Meeting*, 2005;2, 1955–60.
- [13]IEA. *Technology Roadmap: Solar Photovoltaic Energy*, 2014.

- [14] Alsema EA, Nieuwlaar E, *Energy Viability of Photovoltaic Systems, Energy Policy, The viability of solar photovoltaics*, 2000;28(14), 999–1010.
- [15] Wiginton LK, Nguyen HT, Pearce JM. *Quantifying rooftop solar photovoltaic potential for regional renewable energy policy*, *Computers, Environment and Urban Systems* 2010;34, 345- 357.
- [16] Nguyen HT, Pearce JM, Harrap R, Barber G, *The Application of LiDAR to Assessment of Rooftop Solar Photovoltaic Deployment Potential on a Municipal District Unit*, *Sensors*. 2012;12, 4534-4558. [17] Nguyen HT, Pearce JM. *Automated Quantification of Solar Photovoltaic Potential in Cities International Review for Spatial Planning and Sustainable Development*. 2013;1(1), 57-70.
- [18] de Wild-Scholten MJ, Alsema EA, ter Horst EW, Bachler M, Fthenakis VM. *A Cost and Environmental Impact Comparison of Grid-Connected of Rooftop and Ground Based PV Systems*, 21st European Solar Photovoltaic Energy Conference. 2006.
- [19] Nguyen HT, Pearce JM. *Estimating Potential Photovoltaic Yield*
- [19] Nguyen HT, Pearce JM. *Estimating Potential Photovoltaic Yield with r.sun and the Open Source Geographical Resources Analysis Support System Solar Energy*. 2010;84, 831-843.
- [20] Bolinger M. *Utility-Scale Solar 2012: An Empirical Analysis of Project Cost, Performance, and Pricing Trends in the United States*. 2012.
- [21] Fairley P. *Big solar's big surge*, *Spectrum, IEEE*, 2015;52(1), 41-44.
- [22] Nonhebel S. *Renewable Energy and Food Supply: Will There Be Enough Land?*, *Renewable and Sustainable Energy Reviews*. 2005; 9(2) 191–201.
- [23] Calvert K, Pearce JM, Mabee WE. *Toward renewable energy geo-information infrastructures: Applications of GIScience and remote sensing that can build institutional capacity* *Renewable and Sustainable Energy Reviews*. 2013; 18, 416–429.
- [24] Calvert K, Mabee W. *More Solar Farms or More Bioenergy Crops? Mapping and Assessing Potential Land-Use Conflicts among Renewable Energy Technologies in Eastern Ontario, Canada*, *Applied Geography*. 2015;56,209–21.
- [25] United Nations Dept. of Economic and Social Affairs, 2014 at (accessed on April 10, 2015>.
- [26] Talbot G. *L'intégration spatiale et temporelle du partage des ressources dans un système agroforestier noyers-céréales : une clef pour en comprendre la productivité ?* (phdthesis, Université Montpellier II - Sciences et Techniques du Languedoc). 2011.
- [27] Kuemmel B, Langer V, Magid J, De Neergaard A, Porter JR. *Energetic, Economic and Ecological Balances of a Combined Food and Energy System, Biomass and Bioenergy*. 1998; 15(4,5), 407-16.
- [28] Goetzberger A, Zastrow A. *On the Coexistence of Solar-Energy Conversion and Plant Cultivation*, *International Journal of Solar Energy* 1, no. 1. 1982; p .55–69.

- [29] Marrou H, Wery J, Dufour L, Dupraz C. Productivity and Radiation Use Efficiency of Lettuces Grown in the Partial Shade of Photovoltaic Panels, *European Journal of Agronomy*. 2013;44,54–66.
- [30] Marrou H, Guillioni L, Dufour L, Dupraz C, Wery J. Microclimate under agrivoltaicsystems: Is crop growth rate affected in the partial shade of solar panels?. *Agricultural and Forest Meteorology*, 2013;177, 117-132.
- [31] Dupraz C, Marrou H, Talbot G, Dufour L, Nogier A, Ferard Y. Combining solar photovoltaic panels and food crops for optimising land use: Towards new agrivoltaic schemes. *Renewable Energy*, 2011;36(10), 2725-2732.
- [32] Zhu XG, Long SP, Ort DR. What Is the Maximum Efficiency with Which Photosynthesis Can Convert Solar Energy into Biomass?, *Current Opinion in Biotechnology, Food biotechnology / Plant biotechnology*, 2008;19(2),153–59.
- [33] Dupraz C, Talbot G, Marrou H, Wery J, Roux S, Liagre F, Ferard Y, Nogier A. To mix or not to mix: evidences for the unexpected high productivity of new complex agrivoltaic and agroforestry systems. Conference: Resilient Food Systems for a changing world : 5th World Congress of Conservation Agriculture:Resilient Food Systems for a changing world.http://aciagov.au/files/node/13992/to_mix_or_not_to_mix_evidences_for_the_unexpected_19701.pdf. 2011.
- [34] Hallik L, Niinemets Ü, Wright IJ. Are Species Shade and Drought Tolerance Reflected in LeafLevel Structural and Functional Differentiation in Northern Hemisphere Temperate Woody Flora?, *New Phytologist*. 2009; 184(1), 257–74.
- [35] Li F, Meng P, Fu D, Wang B. Light Distribution, Photosynthetic Rate and Yield in a PaulowniaWheat Intercropping System in China. *Agroforestry Systems*. 2008; 74(2), 163-172.
- [36] Lin CH, McGraw RL, George MF, Garrett HE, Shade Effects on Forage Crops with Potential in Temperate Agroforestry Practices, *Agroforestry Systems*. 1998;44(2,3) 109–19.
- [37] Johnston M, Onwueme IC. Effect of Shade of Photosynthetic Pigments in the Tropical Root Crops: Yam, Taro, Tannia, Cassava and Sweet Potato, *Experimental Agriculture* 1998;34(3),301–12.
- [38] Mehleri ED, Zervas PL, Sarimveis H, Palyvos JA, Markatos NC, Determination of the Optimal Tilt Angle and Orientation for Solar Photovoltaic Arrays, *Renewable Energy*. 2010; 35(11),2468–75.
- [39] Skoplaki E, Palyvos JA. Operating Temperature of Photovoltaic Modules: A Survey of Pertinent Correlations, *Renewable Energy*. 2009;34(1),23–29.
- [40] Talbot G, Roux S, Graves A, Dupraz C, Marrou H, Wery J. Relative Yield Decomposition: A Method for Understanding the Behaviour of Complex Crop Models, *Environmental Modelling & Software*, 2014;51, 136–48.
- [41] Gronauer A. Energietechnik. Alternative Energien, http://digisrv-2.biblio.etc.tubs.de:8081/docportal/serolets/MCRFileNodeSerolet/DocPortal_derivate_00033869/jahrbuchagrartechnik2013_energietechnik.pdf. (accessed March 21, 2015).

- [42] Scognamiglio A. *Photovoltaic Greenhouses: A feasible solution for islands? Design, Operation, Monitoring and Lessons Learned from a Real Case Study*. 2015
- [43] Cossu M, Murgia L, Ledda L, Deligios PA, Sirigu A, Chessa F. *Solar Radiation Distribution inside a Greenhouse with South-Oriented Photovoltaic Roofs and Effects on Crop Productivity*, *Applied Energy*, 2014;133,89–100.
- [44] Wu Z, Hou A, Chang C, Huang X, Shi D, Wang Z. *Environmental Impacts of Large-Scale CSP Plants in Northwestern China*, *Environmental Science: Processes & Impacts*. 2014; 16(10),2432–41.
- [45] Burney J, Woltering L, Burke M, Naylor R, Pasternak D. *Solar-Powered Drip Irrigation Enhances Food Security in the Sudano-Sahel*, *Proceedings of the National Academy of Sciences*, 2010;107(5), 1848–53.
- [46] Marcheggiani E, Gulinck H, Galli A. *Detection of Fast Landscape Changes: The Case of Solar Modules on Agricultural Land*, *Computational Science and Its Applications – ICCSA 2013*, ed. Beniamino Murgante et al., *Lecture Notes in Computer Science* 7974. 2013;315–27.
- [47] Wong PW, Shimoda Y, Nonaka M, Inoue M, Mizuno. *Semi-Transparent PV: Thermal Performance, Power Generation, Daylight Modelling and Energy Saving Potential in a Residential Application*, *Renewable Energy*. 2008;33(5),1024–36.
- [48] Brisson N, Gary C, Justes E, Roche R, Mary B, Ripoche D. *An Overview of the Crop Model STICS*, *European Journal of Agronomy, Modelling Cropping Systems: Science, Software and Applications*. 2003;18(3,4), 309-332.
- [49] Elminir HK, Ghitas AE, Hamid RH, El-Hussainy F, Beheary MM, Abdel-Moneim K. *Effect of Dust on the Transparent Cover of Solar Collectors*, *Energy Conversion and Management*. 2006; 47(18,19), 3192–3203.
- [50] Marrou H, Dufour L, Wery J. *How Does a Shelter of Solar Panels Influence Water Flows in a Soil–crop System?*, *European Journal of Agronomy*. 2013; 50,38–51.
- [51] US Bureau of Labor Statistics at (accessed on September 20, 2015).
- [52] US Energy Information Administration, 2015 at (accessed on April 10, 2015).
- [53] Aznar, A.; Doris, E.; Nobler, E.; Truitt, S.; Hurlbut, D.; Bird, L.; Cory, K. *Considerations for Value-of-Solar Methods*. National Renewable Energy Laboratory. 2014.
- [54] Bird, L.; McLaren, J.; Heeter, J.; Linvill, C.; Shenot, J.; Sedano, R.; Migden-Ostrander, J. 2013. *Regulatory Considerations Associated with the Expanded Adoptions of Distributed Solar*. National Renewable Energy Laboratory.
- [55] Denholm, P.; Margolis, R.; Palmintier, B.; Barrows, C.; Ibanez, E.; Bird, L.; Zuboy, J. *Methods for Analyzing the Benefits and Costs of Distributed Photovoltaic Generation to the U.S. Electric Utility System*. 86 ; NREL Report No. TP-6A20-62447.
- [56] Denholm, P., Margolis R.M., Ong S., Roberts B.; *Break-Even Cost for Residential Photo-voltaics in the United States: Key Drivers and Sensitivities*, National Renewable Energy Laboratory (NREL) Technical Report. 2009; 1- 33.

- [57] Ardani, K., Barbose, G., Margolis, R., Wiser, R., Feldman, D., Ong, S. Benchmarking non- hardware balance of system (soft) costs for US photovoltaic systems using a data-driven analysis from PV installer survey results (No. DOE/GO-102012-3834). National Renewable Energy Laboratory (NREL), Golden, CO. 2012
- [58] Jogleka N.R., Graber-Lopez E.S., A Countdown towards Solar Power at Grid Parity:Policy Analysis Based on the Evolution of Price-Performance, Proc. 2008 ISDSI International Conf., 2008, 1-18.
- [59] Price S., Margolis R., 2008 Solar technologies market report, Energy Efficiency & Renewable Energy, US Department of Energy, January 2010, 1-131.
- [60] SEIA. 2015. Solar Industry Data. (accessed on September 27, 2015).
- [61] Ameli, N., & Kammen, D. M. Innovations in financing that drive cost parity for long-term electricity sustainability: An assessment of Italy, Europe's fastest growing solar photovoltaic market. Energy for Sustainable Development, 2014, 19, 130-137.
- [62] Alafita, T., Pearce, J. M.. Securitization of residential solar photovoltaic assets: Costs, risks and uncertainty. Energy Policy, 2014, 67, 488-498.
- [63] Branker, K., Shackles, E., & Pearce, J. M. Peer-to-peer financing mechanisms to accelerate renewable energy deployment. Journal of Sustainable Finance & Investment. 2011, 1(2), 138- 155.
- [64] Renewable Energy Policy Network for the 21st century (REN21), Renewables 2010 Global Status Report, Paris, 2010, 1-80.
- [65] Branker, K., Pathak, M. J. M., Pearce, J. M. A review of solar photovoltaic levelized cost of electricity. Renewable and Sustainable Energy Reviews, 2011, 15(9), 4470-4482.
- [66] Verma LK, Sakhuja M, Son J, Danner AJ, Yang H, Zeng HC. Self-Cleaning and Antireflective Packaging Glass for Solar Modules, Renewable Energy. 2011; 36(9), 2489-93.
- [67] Vanderlinden C. Best Shade-Tolerant Vegetables. Mother Earth news (accessed March 21, 2015).
- [68] Ahsan F. 2014 Top 12 shade tolerant vegetables and herbs for a shady garden (accessed March 21, 2015).
- [69] Fu J, Li CH, Zhao JR, Ma L, Liu TX. Shade-tolerance indices of maize: selection and evaluation., Ying yong sheng tai xue bao = The journal of applied ecology / Zhongguo sheng tai xue xue hui, Zhongguo ke xue yuan Shenyang ying yong sheng tai yan jiu suo zhu ban. 2011; 20(11), 2705-2709.
- [70] Conrad CC, Hilchey KG. A review of citizen science and community-based environmental monitoring: issues and opportunities. Environmental monitoring and assessment, 2011. 176(1- 4), 273- 291.
- [71] Boriss H, Brunke H. (accessed on April 9, 2015) [72] Kenning T. US solar installed capacity to reach 40GW by 2017. PV Tech. (accessed on June 1, 2015)

[72] Kenning T. *US solar installed capacity to reach 40GW by 2017*. PV Tech. (accessed on June 1, 2015)

IJSER